

Shockless Type Proportional Electro-Hydraulic Directional and Flow Control Valves

These valves are well accepted by industrial users as shifting time adjustable type shockless valves. By employing the basic design concept of the “G series solenoid operated directional valves”, we have been successful developing the shifting time adjustable shockless valves with high performance which makes the speed setting possible at any high speed operation.

In combination with the newly developed digital amplifiers, the further enhancement of maneuverability and repeatability of the valves can be realized.

Specifications

Model No.		EDFG-01
Description		
Max. Operating Pressure	Kgf/cm ²	250
Max. Flow	L/min	30
Max. Tank Line Back Pressure	Kgf/cm ²	140
Rated Current	mA	1100
Coil Resistance	Ω	10.8
Hysteresis		5% or Less
Repeatability		1% or Less
Step Response (Typical Rating)		100ms or less
	0 ↔ 100%	
Frequency Response	Phase	20Hz(-90 Degrees)
	Gain	25 Hz (-3dB)
Approx. Mass	Kg.	2.4

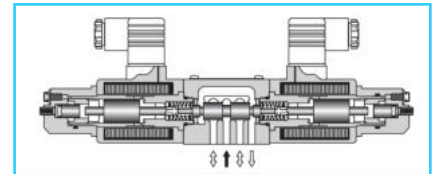
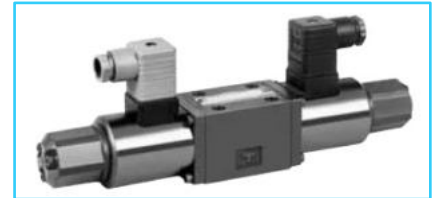

Graphic Symbols

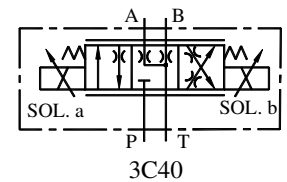
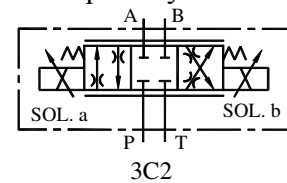

Model Number Designation

F-	EDF	G	-01	-30	-3C2	-XY	-50
Special Seals	Series Number	Type of Mounting	Valve Size	Rated Flow L/min	Spool Type	Direction of Flow	Design Number
F: Special Seals for Phosphate Ester Type Fluid (Omit if not required)	EDF: Shockless Type Proportional Directional and Flow Control Valve	G: Sub-Plate Mounting	01	30	3C2 3C40	XY: Metre – In Metre - Out	50

Attachment

Mounting Bolts

Model Number	Socket Head Cap Screw	Qty.
EDFG-01	M5 x 45 Lg.	4

Sub-Plate

Model Number	Sub-Plate Model Number	Thread Size	Approx. Mass kg
EDFG-01	DSGM-01-3180	1/8 BSP.F	0.8
	DSGM-01X-3180	1/4 BSP.F	

- Sub plates are available. Specify the sub plate model number from the table above. When sub plates are not used, the mounting surface should have a good machined finish.
- Sub plates are those for 1/8 solenoid operated directional valves, see page no. 358

E Series
40Ω-10Ω Series Proportional Electro-Hydraulic
Relief and Flow Control Valves

Applicable Power Amplifiers

For stable Performance, it is recommended that YUKEN's applicable power amplifiers be used.
Model Numbers: AMN-G/W-10

EDFG-01-30-3C※-XY-50

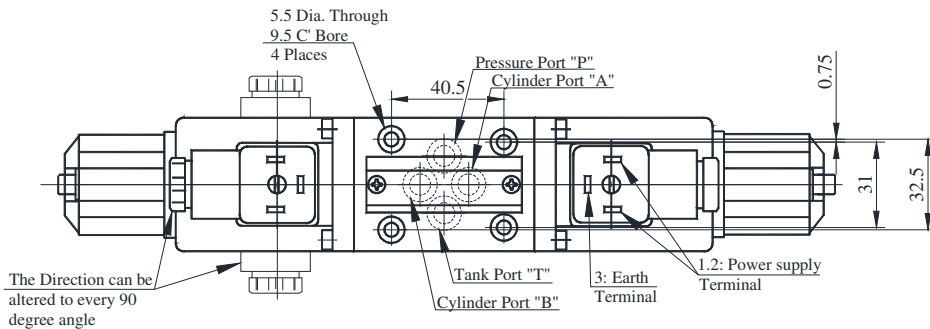

DIMENSIONS IN MILLIMETRES

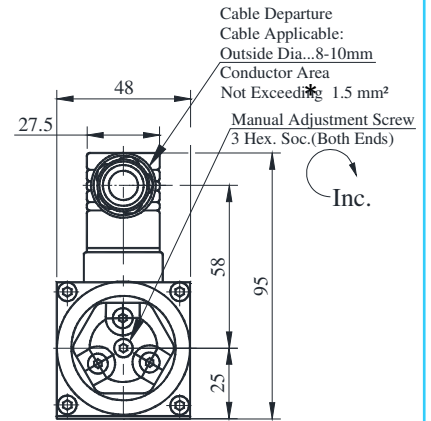
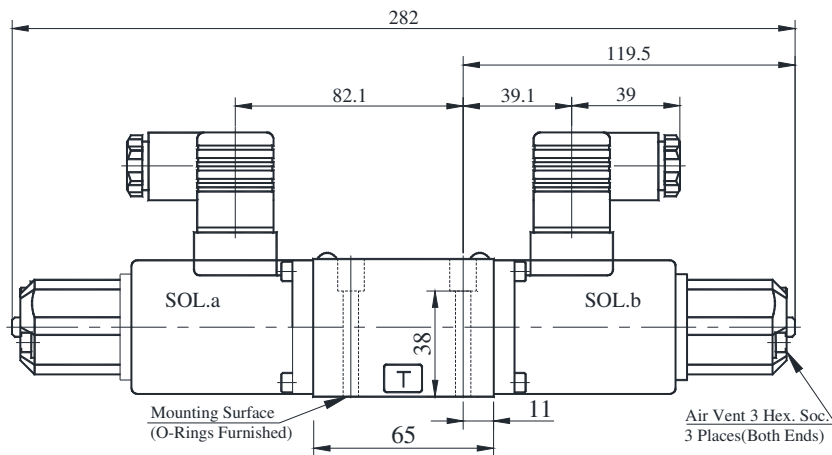

* Under normal conditions, however, this screw must be in its original position

Input Current vs. Flow

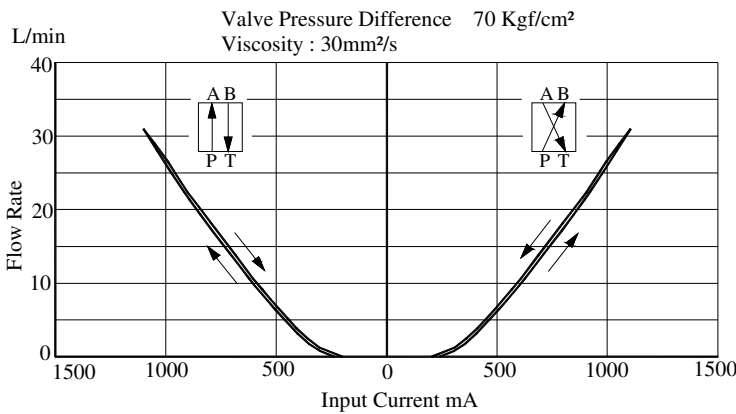

Valve Pressure Difference vs. Flow

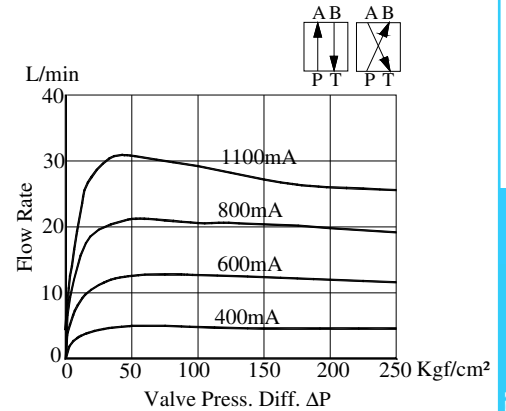

Spare Parts List

List of Seals

Note: When Ordering the seals, please specify the seal kit numbers from the table below.

Item	Name of Parts	Part Numbers	Qty.	Remarks
1	O-Ring	SO-NB-P9	4	Included in Seal Kit Kit No: KS-EDFG-01-50
2	O-Ring	SO-NB-P22	2	
3	O-Ring	SO-NB-P7	2	
4	Fastener Seal	SG-FCF-4	6	
5	O-Ring	SO-NB-P18	2	

Solenoid Assy.

Valve Model Numbers	Solenoid Assy.	Qty.
EDFG-01-30-※-XY-50	E318-Y05M2-28-61	2

Note: The connector assembly GDM-211-B-11 is not included in the solenoid assembly.